

Luxury Lift LLT 950 - Traction Home Elevator - Florida

QUALITY • SAFETY • DEPENDABILITY • BEAUTY • ENGINEERING EXCELLENCE

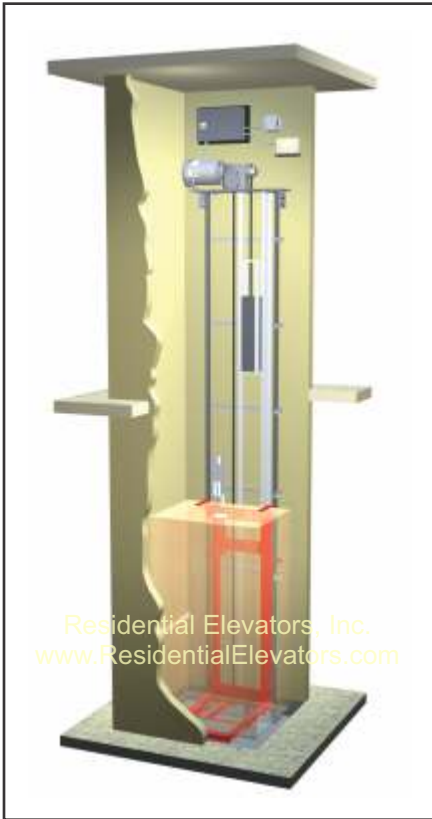

Residential Elevators, Inc. (REI) is pleased to offer the **Luxury Lift LLT 950 - Variable Speed** Traction Residential Elevator.

Benefits: REI's **Luxury Lift LLT Traction Elevator** uses the same technology as **10-50 story commercial buildings** that have been in use for over 100 years. We have developed this technology for a Home Elevator application **without** the need for a **machine room**. That saves the square footage of your home and adds to its value.

Quiet, smooth and reliable operations are the hallmarks of this advanced system and will provide dependable vertical transportation for the life of your home. As quiet as any conventional hydraulic system and a ride similar in smoothness during starting and stopping to most conventional hydraulic systems on the market.

REI's exclusive **Auto Lowering** emergency exit feature allows the **Luxury Lift LLT** to lower automatically to the next landing, allowing passengers to exit safely in the event of a power outage. Standard on all REI Home Elevators.

REI's history of quality engineering means lower maintenance costs.

⑩ **Environmentally Friendly and Energy Efficient**

⑩ **Factory Direct Savings!**

- ⑩ An excellent value in the ultimate home appliance
- ⑩ Unmatched quality and customer service
- ⑩ Many optional features to complement your individual taste and desires
- ⑩ No Machine Room

STANDARD FEATURES

- ⑩ Free job site survey by one of our trained representatives
- ⑩ One (1) year warranty
- ⑩ 950 lb. capacity
- ⑩ Auto Lowering Emergency System
- ⑩ Travel standard up to 50 ft.
- ⑩ Travel speed of 40 ft. per minute
- ⑩ (3) 3/8" Heavy Duty Aircraft cables
- ⑩ PLC (Programmable Logic Controls) Controller
- ⑩ 3/4" sturdy cab walls (7 ply custom cabinet grade material)
- ⑩ Custom made cab and interior to your specifications
- ⑩ Aluminum anodized scissor gate or accordion style solid gate
- ⑩ Standard interior cab color choices: (Pre-finished Maple or Oak and Classic White)
- ⑩ Solid matching hardwood handrail
- ⑩ Recessed lighting
- ⑩ Single integrated car operating panel with built in phone and emergency light
- ⑩ "Car Here" and "In Use" indicators
- ⑩ Meets or exceeds all ASME/ANSI A17.1 National Safety Codes for Elevators - Section 5.3 **Private Residence Elevators and FBC R321.4.**

OPTIONAL SELECTIONS

- ⑩ Woods other than standard
- ⑩ Additional gate(s)
- ⑩ Custom gate(s)
- ⑩ Oversize cab
- ⑩ Over height cab up to 8'-0"
- ⑩ Variety of custom cabs
- ⑩ Observation glass panel inserts
- ⑩ 750 lb. capacity (as necessary by Code in certain areas)
- ⑩ Mirror with hardwood trim
- ⑩ Halogen downlights
- ⑩ Keyed hall station
- ⑩ Attic mount installation
- ⑩ Remote diagnostics and monitoring
- ⑩ Auto homing / auto light / auto run
- ⑩ And much more - Contact your local REI representative for all the details and options



RESIDENTIAL ELEVATORS, INC.

20 Residential Drive, Crawfordville, FL 32327
Ph (850) 926-6022 • Toll Free (800) 832-2004 • Fax (850) 926-5319
www.ResidentialElevators.com
e-mail: sales@ResidentialElevators.com

THE INFORMATION CONTAINED HEREIN IS SOLELY OWNED BY RESIDENTIAL ELEVATORS, INC. ANY REPRODUCTION IN PART OR AS A WHOLE WITHOUT WRITTEN PERMISSION FROM RESIDENTIAL ELEVATORS, INC. IS STRICTLY PROHIBITED.

Luxury Lift LLT 950 - Traction Home Elevator - Florida

Standard Hoistway Plans *

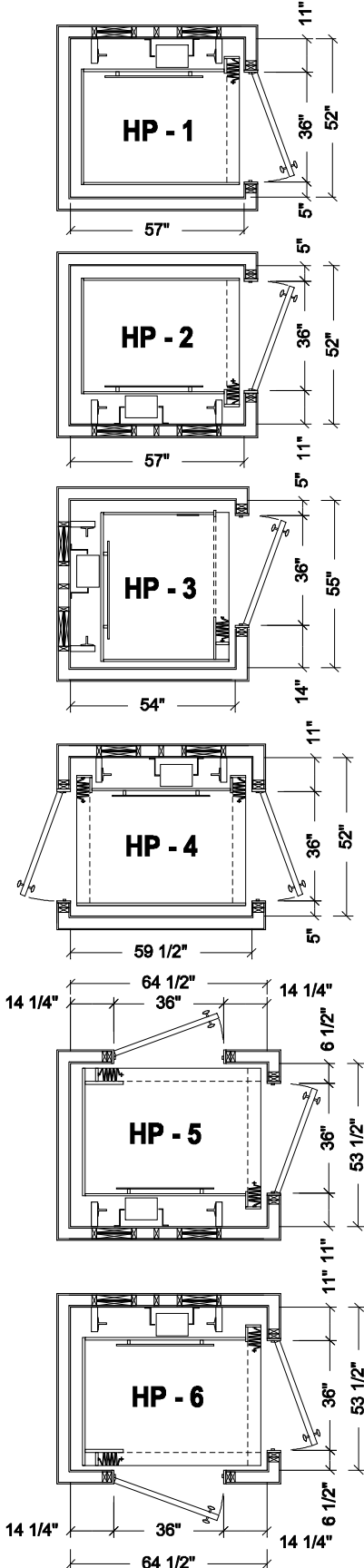

* All dimensions based on Accordion Style Gate

Luxury Lift LLT Traction Contract Specifications

To Specify: The manufacturer shall furnish _____ traction residential elevator(s) (LLT-952, LLT-953, LLT-954, LLT-955) as manufactured by Residential Elevators, Inc. for hoistway plan HP- _____

Design Characteristics: Traction elevator(s) shall have:

Capacity: 950 lb. - Standard, 750 lb. - Optional **Speed:** 40 fpm

Travel Distance: _____ ft. _____ in. (50' - 0" max.)

Landing Served: _____; with openings at _____ front, _____ rear, _____ right, _____ left

Door Size: (_____ w x _____ h) **Door Swing:** Right: _____ Left: _____

Hoistway: (Size _____ x _____) **Cab:** (Size: _____ "w x _____ "d x _____ "h)

Minimum 8'-6" overhead clearance for standard height cab (9'-6" for 8'-0" cabs) **Hoistway Pit:** 14" Minimum

Controller Location: Overhead in shaft (Standard); Attic Mount (Optional)

Std. Cab Interiors: Pre-Finished Birch: _____ Pre-Finished Oak: _____ Classic White Laminate: _____

Optional Species: Mahogany: _____ Cherry: _____ Walnut: _____ Alder: _____ Maple: _____ Bamboo: _____

[Note: All wood species available in stained and lacquered finish or unfinished.]

Cab & Hall Stations: Stainless Steel (#4): _____ Bronze (#4 or Antique): _____ Black: _____

Cab: Standard Residential Elevator shall be suitably finished on the interior side with natural wood grain; constructed of 3/4" 7 ply custom cabinet grade materials. Ceiling to be same species as walls unless specified, and 1" plywood on platform unfinished and ready for floor covering (flooring by others.) Cab is standard equipped with one folding aluminum scissor gate (gold tone or silver tone finish) or accordion style solid vinyl gate (white). It is provided with a gate switch to prevent operation unless the gate is closed. A single recessed incandescent light shall be in the center of the car ceiling. Cab shall be equipped with a solid hardwood handrail.

Guide Rails: Shall be two (2) 8 lb. planed T Section with smooth splices located on one load bearing hoistway wall. Guide rails shall be fastened at 7'-0" intervals by steel brackets. Counterweight rails shall be furnished to guide the counterweight frame.

Machine: Motor to be 2 HP hoist motor with a VFD drive, with brake. Brake shall be spring applied and electrically released and shall release only when drive motor is engaged.

Operation: Controls shall be momentary pressure and completely automatic. Each entrance shall be furnished with a call station. The car shall be furnished with a pushbutton station with one button for each level served. The car push button station shall also contain an emergency stop switch, alarm bell, and light switch, and integrated phone. (required by ASME/ANSI A17.1 National Safety Codes for Elevators - Section 5.3 Private Residence Elevators.) Car and hall pushbutton stations to be brass or antique tone or stainless steel (#4) or Black.

Controller: The controller components shall be enclosed in a metal cabinet. It shall contain the following components: Power relays and overload device suitable for the size motor and power supply. A microprocessor unit for all logical control and safety circuits. All components to be protected by fused circuits. An emergency, battery UPS operated circuit, shall be incorporated in the control logic to automatically provide emergency lighting and lower the lift in the event of an electric power failure. Batteries to be maintained at full charge by a trickle charge circuit during normal operation.

Hoistway Door Interlocks: Electrical / mechanical door locks shall be furnished for all hall doors to prevent elevator operation unless all doors are closed and to prevent opening of door when car is not at that landing.

Car Frame / Suspension: The steel car frame shall be attached to and suspended by three (3) 3/8" dia. heavy duty aircraft cables. The cables shall be fastened to the counterweight frame on one end and pass over the U groove sheave to shackles attached to the car frame and safety device. Should one or more cables break or slacken, a broken rope safety mechanism shall apply two cams to wedge against the elevator guide rails and bring the car to a complete stop.

Installation: Installation to be performed by authorized elevator contractor. All work must be completed in accordance with installation and operating instructions provided by the manufacturer of the elevator and must be in compliance with requirements of the American Standard Safety Code, National Electrical Code, and state and local building codes.

Work By Others:

1. Construction of a suitable, clean, clear, square, plumb (including pit) and legal elevator hoistway consistent with State and Local building codes. (Refer to manufacturer's hoistway plans.)
2. Electrician shall furnish 240 VAC, 30 AMP circuit with 10/3 wire with ground to elevator controller.
3. Electrician shall furnish a 120 VAC, 20 AMP circuit to elevator controller for the car lighting system.
4. Suitable, hinged, solid core hall doors. Door openings are 3'-0" standard unless otherwise specified.
5. 10" deep recessed pit area.
6. Connection of telephone traveling cable to outside central exchange as required by ASME/ANSI A17.1 code.
7. Special engineered Drawings or plans and any State, County or Local Permits.
8. Proper rail blocking support per REI specifications
9. An access door with a minimum clear dimension of 18" H x 24" W is required to access equipment location to be determined by REI.
10. GFCI receptacle to be provided in controller area.
11. A 120 VAC switched light to be located in machinery space.

**Standard Hoistway Plans, as drawn,
are recommended size requirements only.
Contact REI for layout assistance if your needs are different.**

RESIDENTIAL ELEVATORS, INC.

www.ResidentialElevators.com - Toll Free (800) 832 - 2004